



PLDT
Home

CUSTOMER USER GUIDE



If you are a Fibr customer,
your modem set-up should look like this:

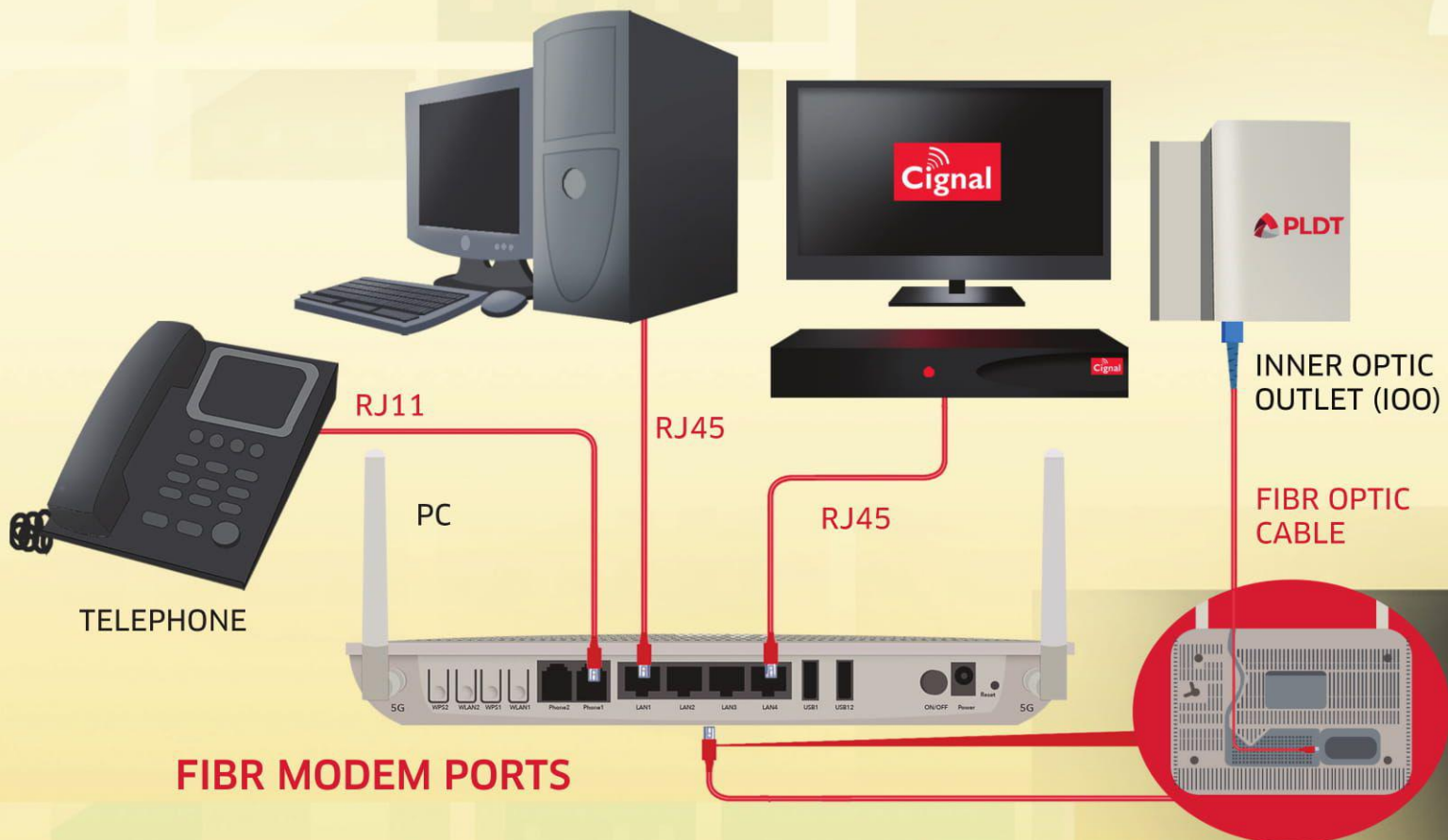

FIBR MODEM PORTS

- Phone1** ➤ This port is for your PLDT telephone connection only.
- Phone 2** ➤ This port is not available for use.
- LAN1** ➤ This port is for your PLDT internet connection only.
- LAN2&3** ➤ This port is for additional PLDT Value-Added Services (VAS) or Cignal IPTV.
- LAN4** ➤ This port is for your Cignal IPTV only.

If you are a DSL customer, your modem set-up should look like this:

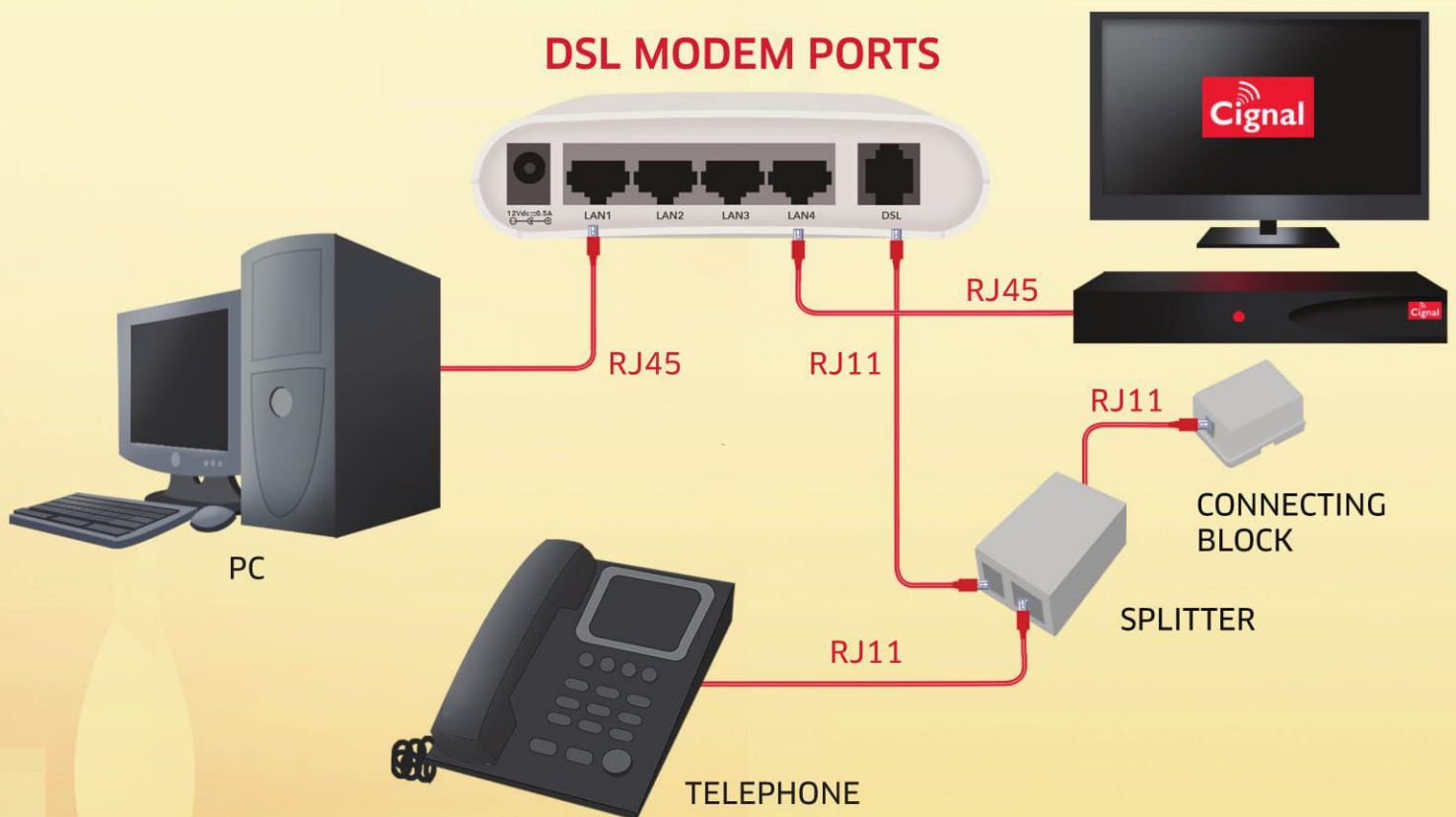

- LAN1** ➤ This port is for your PLDT internet connection only.
- LAN2&3** ➤ This port is for additional PLDT Value-Added Services (VAS) or Signal IPTV.
- LAN4** ➤ This port is for your Signal IPTV only.
- DSL** ➤ This port is for your DSL splitter only.

HERE'S WHAT TO DO IF YOU ARE EXPERIENCING NO INTERNET CONNECTION:

If you are a FIBR customer, follow these steps:

1. Turn the modem off for 5 minutes and then back on to refresh your connection.
2. Wait for the modem to sync within 3 minutes.
3. Check the modem light indicators status.

The light indicators of a FIBR modem should look like this if it's working properly:

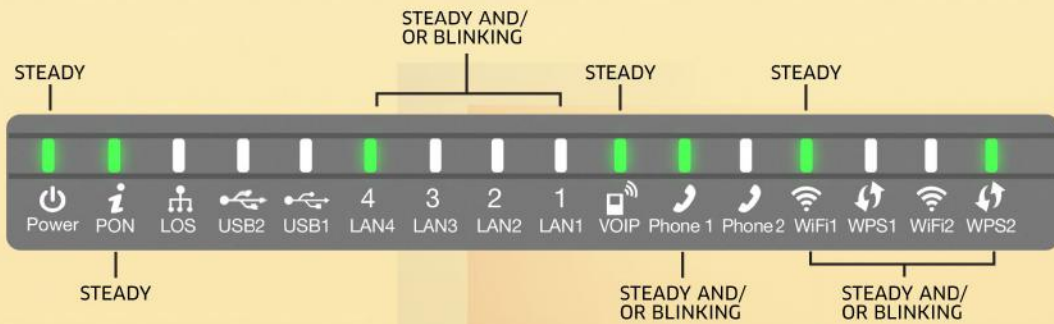

IF	TRY THESE STEPS
1. Power indicator is not lit	<ul style="list-style-type: none">▶ Check if modem is properly plugged in and if power button is pressed in.▶ Ensure that the power cord is connected to the modem.▶ Plug the modem into another power outlet.
2. Power light is orange or red	<ul style="list-style-type: none">▶ Turn the modem off and back on after 5 minutes then check the power light status.
3. Power light is green	<ul style="list-style-type: none">▶ Check the status of the LOS indicator light.
4. LOS indicator light is blinking or steady red	<ul style="list-style-type: none">▶ Ensure that the fiber optic cable is properly connected to the modem
5. LOS indicator light is not on	<ul style="list-style-type: none">▶ Check the status of the PON indicator light.
6. PON Light is off or blinking	<ul style="list-style-type: none">▶ Make sure that the fiber optic cable is connected, both at the bottom of the modem and IOO (Inner Optical Outlet).
7. PON Light is green.	<ul style="list-style-type: none">▶ Connect to the internet and browse any site or application.

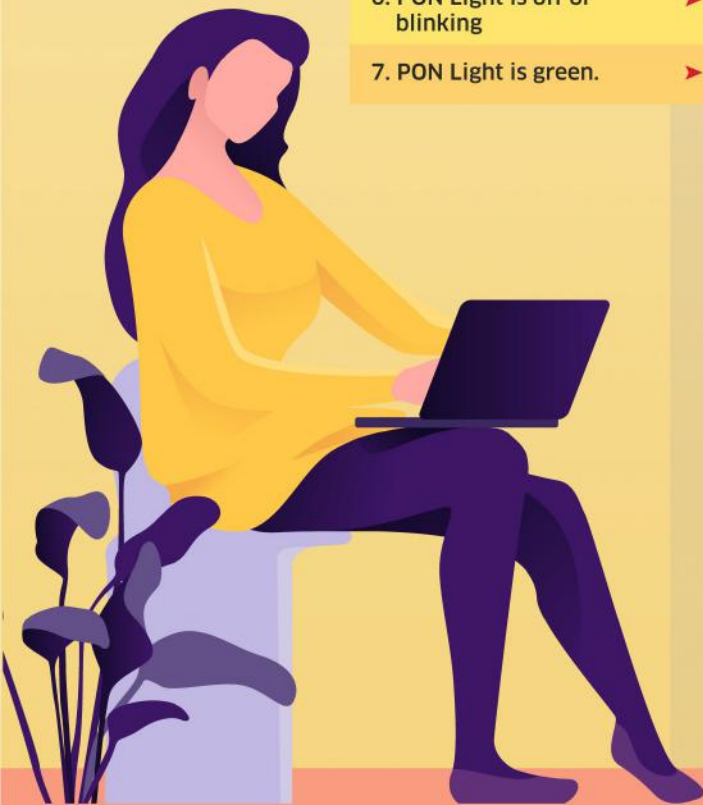

HERE'S WHAT TO DO IF YOU ARE EXPERIENCING NO INTERNET CONNECTION:

If you are a DSL customer, follow these steps:

1. Turn the modem off for 5 minutes and then back on to refresh your connection
2. Wait for the modem to sync within 3 minutes
3. Check the modem light indicators status

The light indicators of a DSL modem should look like this if it's working properly:

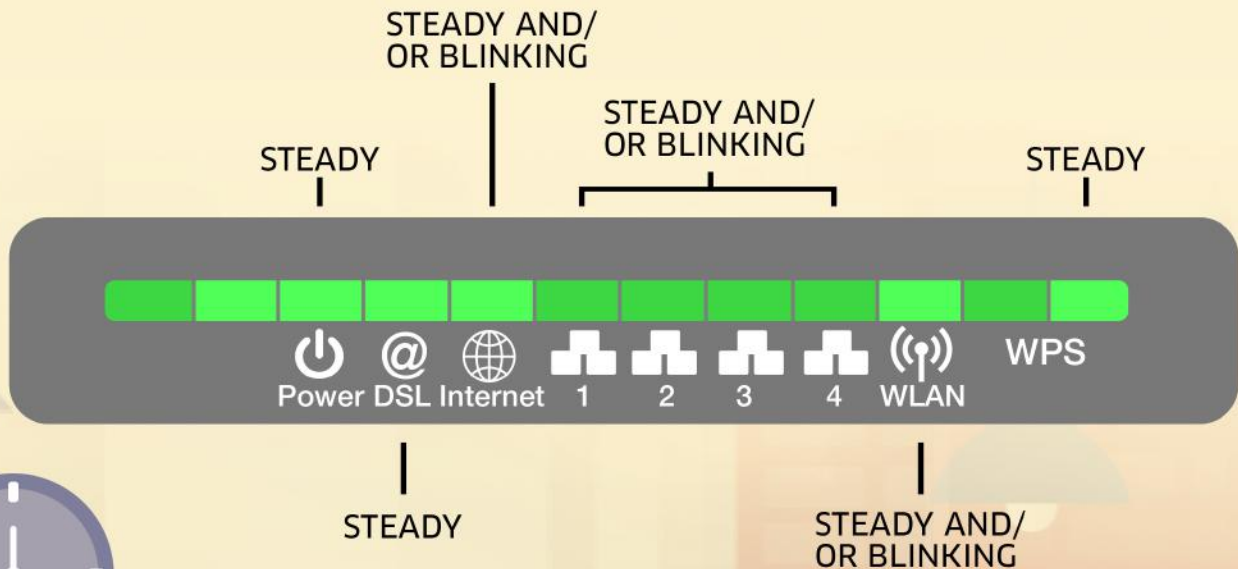

IF	TRY THESE STEPS
1. Power indicator is not lit	<ul style="list-style-type: none">▶ Check if the modem is properly plugged in and if the power button is pressed in.▶ Ensure that the power cord is connected to the modem.▶ Plug the modem into another power outlet.
2. Power light is orange or red	<ul style="list-style-type: none">▶ Turn the modem off and back on after 5 minutes then check the power light status.
3. Power light is green	<ul style="list-style-type: none">▶ Check the status of the DSL indicator light.
4. DSL indicator light is not lit or blinking	<ul style="list-style-type: none">▶ Check if there are loose or damaged cables.▶ Replug the telephone cable (RJ11) from the modem's DSL port and to the splitter's modem port
5. DSL Light is green	<ul style="list-style-type: none">▶ Connect to the internet and browse any site or application.
6. Internet Light is off or red	<ul style="list-style-type: none">▶ Turn the modem off and back on after 5 minutes then check the power light status.



Zzz



HERE ARE SOME ADDITIONAL TIPS FOR WHEN YOU ARE EXPERIENCING NO INTERNET CONNECTION:

If you're connected via Wi-Fi, try these steps:



- Disconnect and reconnect your device to the Wi-Fi connection
- Forget the Wi-Fi connection from the device, reconnect and input your username and password.
- Browse using another device to isolate if the connection issue is device-related.
- If available, connect via LAN to isolate if the issue is with the Wi-Fi connection.

If you are connected via LAN and the LAN status icon is a red X mark, try these steps:



- Ensure that the LAN cable is not damaged.
- Properly connect the LAN cable to the modem's port and the device port.
- Check if the LAN ethernet adapter is enabled on computer.

If you are connected via LAN and the LAN status icon is a yellow triangle with an exclamation point, try these steps:



- Turn the modem off for 5 minutes and then back on to refresh your connection.
- Follow your computer's built-in troubleshooting process.

Common Browser Errors



- If the error shows "the proxy server isn't responding", disable the proxy server.



- If the error shows "this page can't be displayed", turn the modem off for 5 minutes and then back on to refresh your connection.



HERE'S WHAT TO DO IF WEBSITES AND APPS ARE TAKING TOO LONG TO LOAD:

1. Turn the modem off for 5 minutes and then back on to refresh your connection.
2. Wait for the modem to sync within 3 minutes.
3. Limit the number of devices connected to the network.
4. Delete the browser cookies and cache then restart the device.
5. Perform a speed test via speedtest.net. Ensure that only one user is connected and choose PLDT as the server.



WEBSITE AND APPS
ARE TAKING
LONG TO LOAD

How to change your Wi-Fi network name (SSID)

1. On your browser, type <https://192.168.1.1> then press enter.
A login window will appear.
2. Type the default username: admin, password: 1234 to log in.
3. Click "Setup" found on the upper-hand side of the page.
4. Choose "Basic" from the left-hand side to change your Wi-Fi network name.

How to change your Wi-Fi password

1. On your browser, type <https://192.168.1.1> then press enter.
A login window will appear.
2. Type the default username: admin, password: 1234 to log in.
3. Click "Setup" found on the upper-hand side of the page.
4. Go to "Security Setting" to change your Wi-Fi password.
5. Your device will be automatically disconnected from the Wi-Fi connection.
6. Reconnect then input the new password.



HERE'S WHAT TO DO IF YOU ARE EXPERIENCING NO DIAL TONE:

If you are a FIBR customer, follow these steps:

1. Turn the modem off for 5 minutes and then back on to refresh your connection
2. Wait for the modem to sync within 3 minutes
3. Check the modem light indicators status

The light indicators of a FIBR modem should look like this if it's working properly:

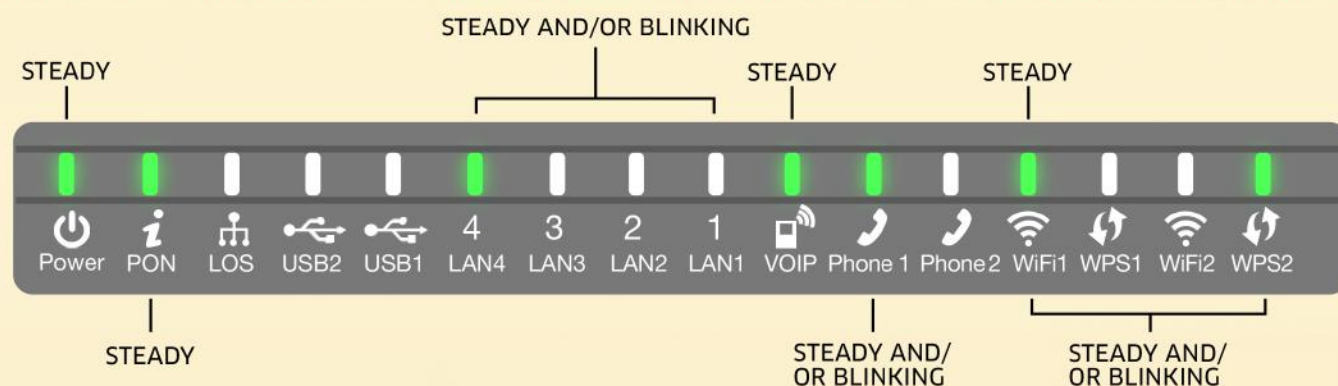

IF	TRY THESE STEPS
1. Power indicator is not lit	<ul style="list-style-type: none">▶ Check if the modem is properly plugged in and if the power button is pressed in.▶ Ensure that the power cord is connected to the modem.▶ Plug the modem into another power outlet.
2. Power light is orange or red	<ul style="list-style-type: none">▶ Turn the modem off and back on after 5 minutes then check the powerlight status.
3. Power light is green	<ul style="list-style-type: none">▶ Check the status of the LOS indicator light.
4. LOS indicator light is blinking or steady red	<ul style="list-style-type: none">▶ Ensure that the fiber optic cable is properly connected to the modem.
5. LOS indicator light is not on	<ul style="list-style-type: none">▶ Check the status of the VOIP indicator light.
6. VOIP indicator light is not lit or is blinking	<ul style="list-style-type: none">▶ Turn the modem off and back on after 5 minutes then check the power light status.▶ Check if the handset has dial tone.

4. Check the telephone connection

- ▶ Check for any loose or damaged telephone cables and wires. If the telephone cable (RJ11) is damaged, it may need to be replaced.
- ▶ Ensure that the telephone cable (RJ11) from the telephone is properly connected to the Phone 1 slot of the modem.



5. Check the telephone handset

- ▶ Check for any noise or static sound.
- ▶ Check the telephone coil cord (RJ9) port if damaged. See image on the right side)
- ▶ Press the plunger for at least 5 seconds. If the plunger stays down, the telephone unit is defective.
- ▶ Check if there is a problem with your telephone unit by connecting another telephone unit to the line.



HERE'S WHAT TO DO IF YOU ARE EXPERIENCING NO DIAL TONE:

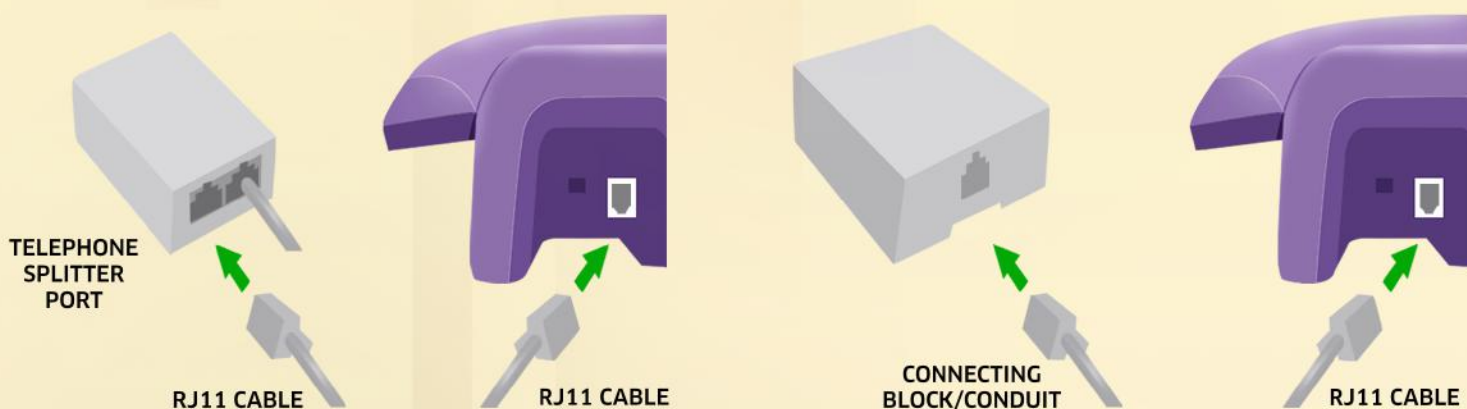

If you are a DSL customer, follow these steps:

1. Check the telephone connection

- ▶ Check for any loose or damaged cables. If the telephone cable (RJ11) is damaged, it may need to be replaced. (See image above)
- ▶ Unplug and replug the telephone cable (RJ11) from the telephone unit port and splitter's telephone port.
- ▶ Check if there is a problem with the splitter by unplugging the telephone cable (RJ11) from the splitter and connecting it directly to the connecting block. If you hear a dial tone, the splitter might be defective.

2. Check the telephone handset

- ▶ Check for any noise or static sound.
- ▶ Check the telephone coil cord (RJ9) port if damaged.
- ▶ Press the plunger for at least 5 seconds. If the plunger stays down, the telephone unit is defective.
- ▶ Check if there is a problem with your telephone unit by connecting another telephone unit to the line.



If the problem persists after doing the troubleshooting steps, you may follow these steps to file a service ticket through the PLDT Home app or the PLDT MyHome website.

PLDT HOME APP

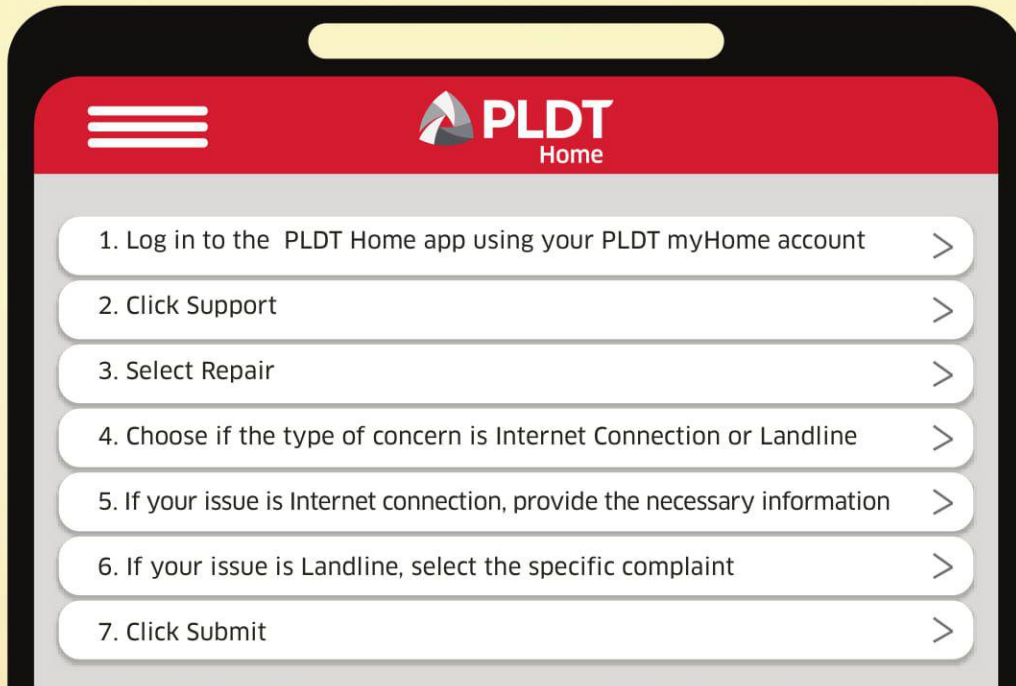

PLDT MYHOME WEBSITE

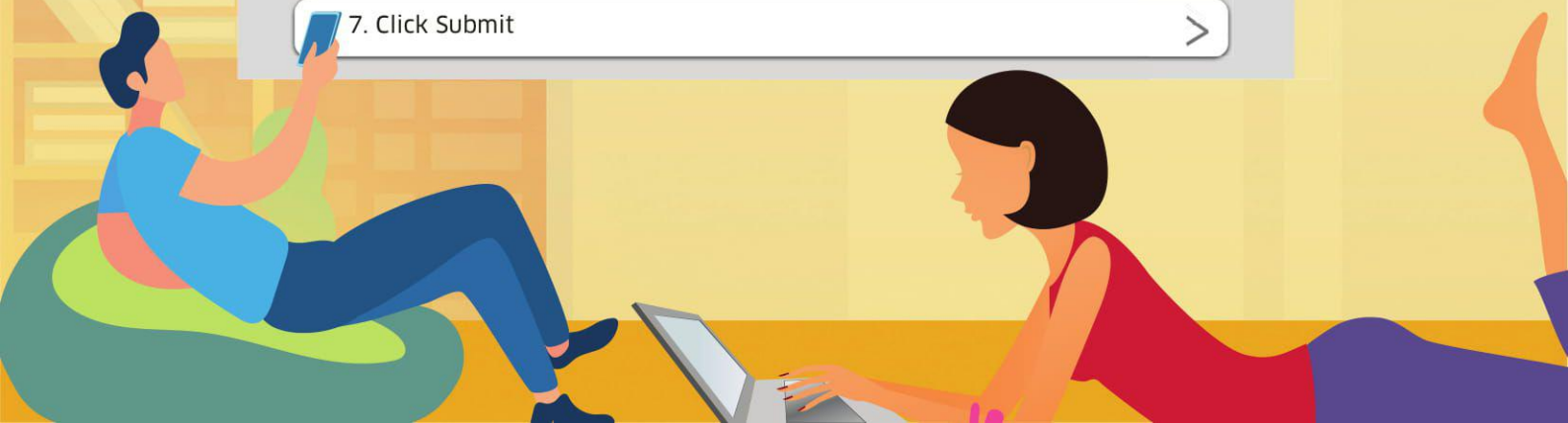
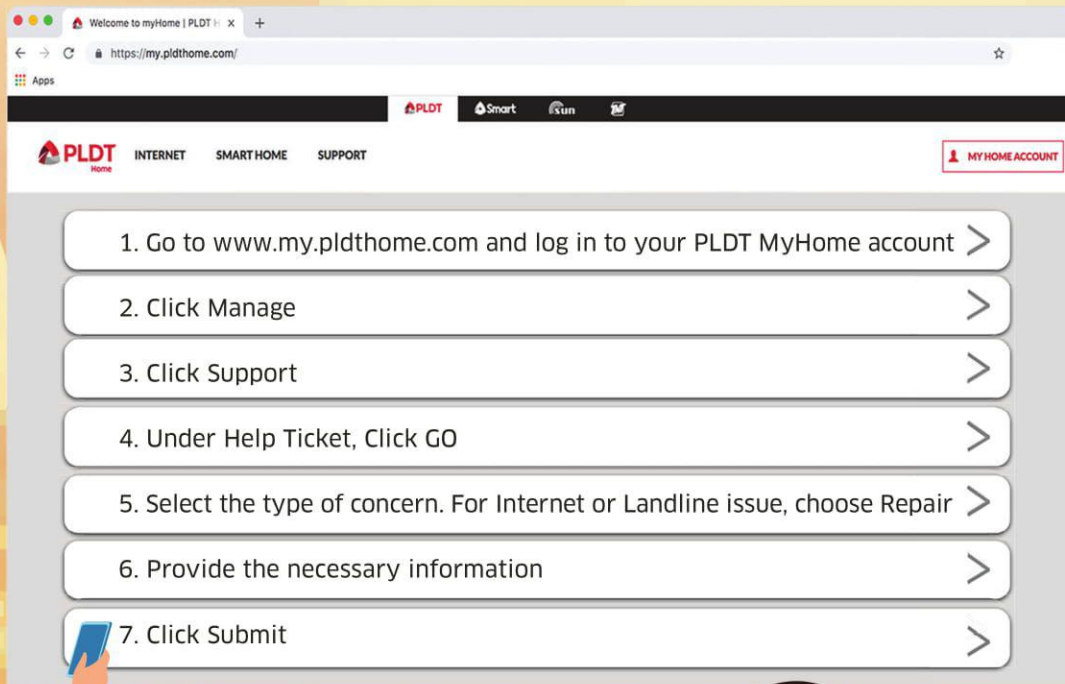



If you need further assistance,
visit the PLDT Home Support page
at pldthome.com/support
or connect with us through

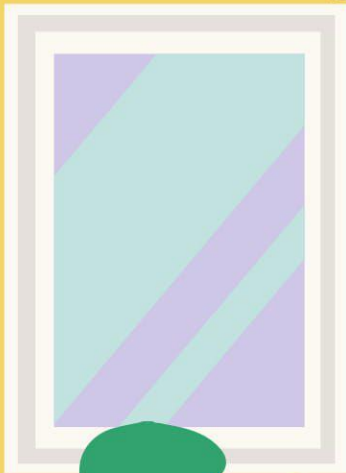

@PLDTHome



@PLDT_Cares



171 PLDT Home Hotline

